

Commercial “L” Series, SnPb Termination, C0G Dielectric

10VDC-200VDC (Commercial Grade)

Overview

KEMET’s Commercial “L” Series with Tin/Lead Termination surface mount capacitors in C0G dielectric are designed to meet the needs of critical applications where tin/lead end metallization is required. KEMET’s tin/lead electroplating process is designed to meet a 5% minimum lead content and address concerns for a more robust and reliable lead containing termination system. As the bulk of the electronics industry moves towards RoHS compliance, KEMET continues to provide tin/lead terminated products for military, aerospace and industrial applications and will ensure customers have a stable and long-term source of supply.

KEMET’s C0G dielectric features a 125°C maximum operating temperature and is considered “stable.” The Electronics Components, Assemblies & Materials Association (EIA) characterizes C0G dielectric as a Class I material. Components of this classification are temperature compensating and are suited for resonant circuit applications or those where Q and stability of capacitance characteristics are required. C0G exhibits no change in capacitance with respect to time and voltage and boasts a negligible change in capacitance with reference to ambient temperature. Capacitance change is limited to $\pm 30\text{ppm}/^\circ\text{C}$ from -55°C to $+125^\circ\text{C}$.

Benefits

- -55°C to $+125^\circ\text{C}$ operating temperature range
- Reliable and robust termination system
- EIA 0201, 0402, 0603, 0805, 1206, 1210, 1808, 1812, 1825, 2220 & 2225 case sizes
- DC voltage ratings of 10V, 16V, 25V, 50V, 100V and 200V
- Capacitance offerings ranging from 0.5pF up to 0.47 μF
- Available capacitance tolerances of $\pm 0.25\text{pF}$, $\pm 0.5\text{pF}$, $\pm 1\%$, $\pm 2\%$, $\pm 5\%$, $\pm 10\%$ and $\pm 20\%$
- No piezoelectric noise
- Extremely low ESR and ESL
- High thermal stability
- High ripple current capability
- Preferred capacitance solution at line frequencies and into the MHz range
- No capacitance change with respect to applied rated DC voltage
- Negligible capacitance change with respect to temperature from -55°C to $+125^\circ\text{C}$
- No capacitance decay with time
- Non-polar device, minimizing installation concerns
- SnPb plated termination finish (5% min)
- Flexible termination option available upon request
- Available for other surface mount products, additional dielectrics and higher voltage ratings upon request

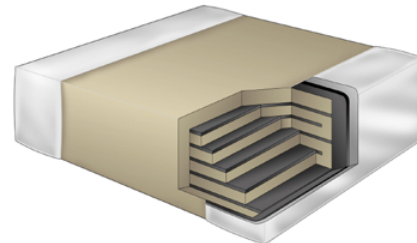

Ordering Information

C	1206	C	104	J	3	G	A	L	TU
Ceramic	Case Size (L" x W")	Specification/ Series	Capacitance Code (pF)	Capacitance Tolerance ¹	Voltage	Dielectric	Failure Rate/ Design	Termination Finish ²	Packaging/Grade (C-Spec) ³
	0402 0603 0805 1206 1210 1808 1812 1825 2220 2225	C = Standard	2 Sig. Digits + Number of Zeros Use 9 for 1.0 - 9.9pF Use 8 for 0.5 - .99pF ex. 2.2pF = 229 ex. 0.5pF = 508	C = $\pm 0.25\text{pF}$ D = $\pm 0.5\text{pF}$ F = $\pm 1\%$ G = $\pm 2\%$ J = $\pm 5\%$ K = $\pm 10\%$ M = $\pm 20\%$	8 = 10V 4 = 16V 3 = 25V 5 = 50V 1 = 100V 2 = 200V	G = C0G	A = N/A	L = SnPb (5% min)	Blank = Bulk TU = 7" Reel Unmarked

¹ Additional capacitance tolerance offerings may be available. Contact KEMET for details.

² Additional termination finish options may be available. Contact KEMET for details.

³ Additional reeling or packaging options may be available. Contact KEMET for details.

Dimensions – Millimeters (Inches)

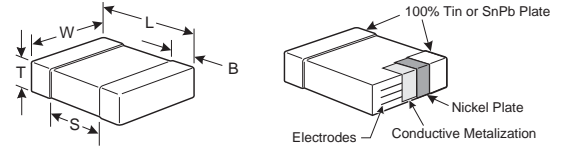

EIA Size Code	Metric Size Code	L Length	W Width	T Thickness	B Bandwidth	S Separation Min.	Mounting Technique
0402	1005	1.00 (.040) ± 0.05 (.002)	0.50 (.020) ± 0.05 (.002)	See Table 2 for Thickness	0.30 (.012) ± 0.10 (.004)	0.30 (.012)	Solder Reflow Only
0603	1608	1.60 (.063) ± 0.15 (.006)	0.80 (.032) ± 0.15 (.006)		0.35 (.014) ± 0.15 (.006)	0.70 (.028)	Solder Wave or Solder Reflow
0805	2012	2.00 (.079) ± 0.20 (.008)	1.25 (.049) ± 0.20 (.008)		0.50 (0.02) ± 0.25 (.010)	0.75 (.030)	
1206	3216	3.20 (.126) ± 0.20 (.008)	1.60 (.063) ± 0.20 (.008)		0.50 (0.02) ± 0.25 (.010)	N/A	Solder Reflow Only
1210	3225	3.20 (.126) ± 0.20 (.008)	2.50 (.098) ± 0.20 (.008)		0.50 (0.02) ± 0.25 (.010)		
1808	4520	4.70 (.185) ± 0.50 (.020)	2.00 (.079) ± 0.20 (.008)		0.60 (.024) ± 0.35 (.014)		
1812	4532	4.50 (.177) ± 0.30 (.012)	3.20 (.126) ± 0.30 (.012)		0.60 (.024) ± 0.35 (.014)		
1825	4564	4.50 (.177) ± 0.30 (.012)	6.40 (.252) ± 0.40 (.016)		0.60 (.024) ± 0.35 (.014)		
2220	5650	5.70 (.224) ± 0.40 (.016)	5.00 (.197) ± 0.40 (.016)		0.60 (.024) ± 0.35 (.014)		
2225	5664	5.60 (.220) ± 0.40 (.016)	6.40 (.248) ± 0.40 (.016)		0.60 (.024) ± 0.35 (.014)		

Applications

Typical applications include military, aerospace and other high reliability applications.

Qualification/Certification

Commercial grade products are subject to internal qualification. Details regarding test methods and conditions are referenced in Table 4, Performance and Reliability.

Environmental Compliance

These devices do not meet RoHS criteria due to the concentration of Pb containment in the termination finish

Electrical Parameters/Characteristics

Item	Parameters/Characteristics
Operating Temperature Range	-55°C to +125°C
Capacitance Change with Reference to +25°C and 0 Vdc Applied (TCC)	±30PPM/°C
Aging Rate (Max % Cap Loss/Decade Hour)	0%
Dielectric Withstanding Voltage	250% of rated voltage (5 ± 1 seconds and charge/discharge not exceeding 50mA)
Dissipation Factor (DF) Maximum Limit @ 25°C	0.1%
Insulation Resistance (IR) Limit @ 25°C	1000 megohm microfarads or 100GΩ (Rated voltage applied for 120 ± 5 secs @ 25°C)

To obtain IR limit, divide MΩ-μF value by the capacitance and compare to GΩ limit. Select the lower of the two limits.

Capacitance and Dissipation Factor (DF) measured under the following conditions:

1MHz ± 100kHz and 1.0Vrms ± 0.2V if capacitance ≤1000pF

1kHz ± 50Hz and 1.0Vrms ± 0.2V if capacitance >1000pF

Note: When measuring capacitance it is important to ensure the set voltage level is held constant. The HP4284 & Agilent E4980 have a feature known as Automatic Level Control (ALC). The ALC feature should be switched to "ON".

Post Environmental Limits

High Temperature Life, Biased Humidity, Moisture Resistance					
Dielectric	Rated DC Voltage	Capacitance Value	DF (%)	Cap Shift	IR
C0G	All	All	0.5	0.3% or ± 0.25 pF	10% of Initial Limit

Table 1A – (0402 - 1206 Case Sizes)

Cap	Cap Code	Series		C0402						C0603						C0805						C1206											
		Voltage Code		8	4	3	5	1	2	8	4	3	5	1	2	8	4	3	5	1	2	8	4	3	5	1	2						
		Voltage DC		10	16	25	50	100	200	10	16	25	50	100	200	10	16	25	50	100	200	10	16	25	50	100	200						
		Cap Tolerance		Product Availability and Chip Thickness Codes - See Table 2 for Chip Thickness Dimensions																													
0.50-0.75 pF	508-759	C	D					BB	BB	BB	BB				CB	CB	CB	CB	CB	CB	DC	DC	DC	DC	DC	DC	EB	EB	EB	EB	EB	EB	
1.0-2.4 pF	109-249	C	D					BB	BB	BB	BB				CB	CB	CB	CB	CB	CB	DC	DC	DC	DC	DC	DC	EB	EB	EB	EB	EB	EB	
2.7-5.1 pF	279	C	D			J	K	M	BB	BB	BB	BB			CB	CB	CB	CB	CB	CB	DC	DC	DC	DC	DC	DC	EB	EB	EB	EB	EB	EB	
5.6 pF	569	C	D		G	J	K	M	BB	BB	BB	BB			CB	CB	CB	CB	CB	CB	DC	DC	DC	DC	DC	DC	EB	EB	EB	EB	EB	EB	
6.2 pF	629	C	D		G	J	K	M	BB	BB	BB	BB			CB	CB	CB	CB	CB	CB	DC	DC	DC	DC	DC	DC	EB	EB	EB	EB	EB	EB	
6.8 pF	689	C	D		G	J	K	M	BB	BB	BB	BB			CB	CB	CB	CB	CB	CB	DC	DC	DC	DC	DC	DC	EB	EB	EB	EB	EB	EB	
7.5 pF	759	C	D		G	J	K	M	BB	BB	BB	BB			CB	CB	CB	CB	CB	CB	DC	DC	DC	DC	DC	DC	EB	EB	EB	EB	EB	EB	
8.2 pF	829	C	D		G	J	K	M	BB	BB	BB	BB			CB	CB	CB	CB	CB	CB	DC	DC	DC	DC	DC	DC	EB	EB	EB	EB	EB	EB	
9.1 pF	919	C	D		G	J	K	M	BB	BB	BB	BB			CB	CB	CB	CB	CB	CB	DC	DC	DC	DC	DC	DC	EB	EB	EB	EB	EB	EB	
10 pF	100	C	D		G	J	K	M	BB	BB	BB	BB			CB	CB	CB	CB	CB	CB	DC	DC	DC	DC	DC	DC	EB	EB	EB	EB	EB	EB	
11 pF	110	C	D		G	J	K	M	BB	BB	BB	BB			CB	CB	CB	CB	CB	CB	DC	DC	DC	DC	DC	DC	EB	EB	EB	EB	EB	EB	
12 pF	120	D	D		G	J	K	M	BB	BB	BB	BB			CB	CB	CB	CB	CB	CB	DC	DC	DC	DC	DC	DC	EB	EB	EB	EB	EB	EB	
13 pF	130	D	D		G	J	K	M	BB	BB	BB	BB			CB	CB	CB	CB	CB	CB	DC	DC	DC	DC	DC	DC	EB	EB	EB	EB	EB	EB	
15 pF	150	D	D		G	J	K	M	BB	BB	BB	BB			CB	CB	CB	CB	CB	CB	DC	DC	DC	DC	DC	DC	EB	EB	EB	EB	EB	EB	
16 pF	160	D	D		G	J	K	M	BB	BB	BB	BB			CB	CB	CB	CB	CB	CB	DC	DC	DC	DC	DC	DC	EB	EB	EB	EB	EB	EB	
18 pF	180	D	F	G	J	K	M	BB	BB	BB	BB			CB	CB	CB	CB	CB	CB	CB	DC	DC	DC	DC	DC	DC	EB	EB	EB	EB	EB	EB	
20 pF	200	D	F	G	J	K	M	BB	BB	BB	BB			CB	CB	CB	CB	CB	CB	CB	DC	DC	DC	DC	DC	DC	EB	EB	EB	EB	EB	EB	
22 pF	220	D	F	G	J	K	M	BB	BB	BB	BB			CB	CB	CB	CB	CB	CB	CB	DC	DC	DC	DC	DC	DC	EB	EB	EB	EB	EB	EB	
24 pF	240	D	F	G	J	K	M	BB	BB	BB	BB			CB	CB	CB	CB	CB	CB	CB	DC	DC	DC	DC	DC	DC	EB	EB	EB	EB	EB	EB	
27 pF	270	F	F	G	J	K	M	BB	BB	BB	BB			CB	CB	CB	CB	CB	CB	CB	DC	DC	DC	DC	DC	DC	EB	EB	EB	EB	EB	EB	
30 pF	300	F	F	G	J	K	M	BB	BB	BB	BB			CB	CB	CB	CB	CB	CB	CB	DC	DC	DC	DC	DC	DC	EB	EB	EB	EB	EB	EB	
33 pF	330	F	F	G	J	K	M	BB	BB	BB	BB			CB	CB	CB	CB	CB	CB	CB	DC	DC	DC	DC	DC	DC	EB	EB	EB	EB	EB	EB	
36 pF	360	F	F	G	J	K	M	BB	BB	BB	BB			CB	CB	CB	CB	CB	CB	CB	DC	DC	DC	DC	DC	DC	EB	EB	EB	EB	EB	EB	
39 pF	390	F	F	G	J	K	M	BB	BB	BB	BB			CB	CB	CB	CB	CB	CB	CB	DC	DC	DC	DC	DC	DC	EB	EB	EB	EB	EB	EB	
43 pF	430	F	F	G	J	K	M	BB	BB	BB	BB			CB	CB	CB	CB	CB	CB	CB	DC	DC	DC	DC	DC	DC	EB	EB	EB	EB	EB	EB	
47 pF	470	F	F	G	J	K	M	BB	BB	BB	BB			CB	CB	CB	CB	CB	CB	CB	DC	DC	DC	DC	DC	DC	EB	EB	EB	EB	EB	EB	
51 pF	510	F	F	G	J	K	M	BB	BB	BB	BB			CB	CB	CB	CB	CB	CB	CB	DC	DC	DC	DC	DC	DC	EB	EB	EB	EB	EB	EB	
56 pF	560	F	F	G	J	K	M	BB	BB	BB	BB			CB	CB	CB	CB	CB	CB	CB	DC	DC	DC	DC	DC	DC	EB	EB	EB	EB	EB	EB	
62 pF	620	F	F	G	J	K	M	BB	BB	BB	BB			CB	CB	CB	CB	CB	CB	CB	DC	DC	DC	DC	DC	DC	EB	EB	EB	EB	EB	EB	
68 pF	680	F	F	G	J	K	M	BB	BB	BB	BB			CB	CB	CB	CB	CB	CB	CB	DC	DC	DC	DC	DC	DC	EB	EB	EB	EB	EB	EB	
75 pF	750	F	F	G	J	K	M	BB	BB	BB	BB			CB	CB	CB	CB	CB	CB	CB	DC	DC	DC	DC	DC	DC	EB	EB	EB	EB	EB	EB	
82 pF	820	F	F	G	J	K	M	BB	BB	BB	BB			CB	CB	CB	CB	CB	CB	CB	DC	DC	DC	DC	DC	DC	EB	EB	EB	EB	EB	EB	
91 pF	910	F	F	G	J	K	M	BB	BB	BB	BB			CB	CB	CB	CB	CB	CB	CB	DC	DC	DC	DC	DC	DC	EB	EB	EB	EB	EB	EB	
100 pF	101	F	F	G	J	K	M	BB	BB	BB	BB	BB	UD		CB	CB	CB	CB	CB	CB	DC	DC	DC	DC	DC	DC	EB	EB	EB	EB	EB	EB	
110-180 pF	111-181	F	F	G	J	K	M	BB	BB	BB	BB	BB	UD		CB	CB	CB	CB	CB	CB	DC	DC	DC	DC	DC	DC	EB	EB	EB	EB	EB	EB	
200-330 pF	201-331	F	F	G	J	K	M	BB	BB	BB	BB	BB	UD		CB	CB	CB	CB	CB	CB	UD	DC	DC	DC	DC	DC	EB	EB	EB	EB	EB	EB	
360-430 pF	361-431	F	F	G	J	K	M	BB	BB	BB	BB	BB	UD		CB	CB	CB	CB	CB	CB	UD	DC	DC	DC	DC	DC	EB	EB	EB	EB	EB	EB	
470 pF	471	F	F	G	J	K	M	BB	BB	BB	BB	BB	UD		CB	CB	CB	CB	CB	CB	UD	DC	DC	DC	DC	DC	EB	EB	EB	EB	EB	EB	
510 pF	511	F	F	G	J	K	M	BB	BB	BB	BB	BB	UD		CB	CB	CB	CB	CB	CB	UD	DC	DC	DC	DC	DC	EB	EB	EB	EB	EB	EB	
560 pF	561	F	F	G	J	K	M	BB	BB	BB	BB	BB	UD		CB	CB	CB	CB	CB	CB	UD	DC	DC	DC	DC	DC	EB	EB	EB	EB	EB	EB	
620-820 pF	621	F	F	G	J	K	M	BB	BB	BB	BB	BB	UD		CB	CB	CB	CB	CB	CB	UD	DC	DC	DC	DC	DC	EB	EB	EB	EB	EB	EC	
910 pF	911	F	F	G	J	K	M	BB	BB	BB	BB	BB	UD		CB	CB	CB	CB	CB	CB	UD	DC	DC	DC	DC	DC	EB	EB	EB	EB	EB	ED	
1,000 pF	102	F	F	G	J	K	M	BB	BB	BB	BB	BB	UD		CB	CB	CB	CB	CB	CB	UD	DC	DC	DC	DC	DC	EB	EB	EB	EB	EB	EE	
1,100 pF	112	F	F	G	J	K	M	BB	BB	BB	BB	BB	UD		CB	CB	CB	CB	CB	CB	UD	DC	DC	DC	DC	DC	EB	EB	EB	EB	EB	EB	
1,200 pF	122	F	F	G	J	K	M	BB	BB	BB	BB	BB	UD		CB	CB	CB	CB	CB	CB	UD	DC	DC	DC	DC	DC	EB	EB	EB	EB	EB	EB	
1,300 pF	132	F	F	G	J	K	M	BB	BB	BB	BB	BB	UD		CB	CB	CB	CB	CB	CB	UD	DD	DD	DD	DD	DD	EB	EB	EB	EB	EB	EC	
1,500 pF	152	F	F	G	J	K	M	BB	BB	BB	BB	BB	UD		CB	CB	CB	CB	CB	CB	UD	DD	DD	DD	DD	DD	EB	EB	EB	EB	EB	EC	
1,600 pF	162	F	F	G	J	K	M	BB	BB	BB	BB	BB	UD		CB	CB	CB	CB	CB	CB	UD	DD	DD	DD	DD	DD	EB	EB	EB	EB	EB	ED	
1,800 pF	182	F	F	G	J	K	M	BB	BB	BB	BB	BB	UD		CB	CB	CB	CB	CB	CB	UD	DD	DD	DD	DD	DD	EB	EB	EB	EB	EB	ED	
2,000 pF	202	F	F	G	J	K	M	BB	BB	BB	BB	BB	UD		CB	CB	CB	CB	CB	CB	UD	DC	DC	DC	DC	DC	EB	EB	EB	EB	EB	ED	
2,200 pF	222	F	F	G	J	K	M	BB	BB	BB	BB	BB	UD		CB	CB	CB	CB	CB	CB	UD	DC	DC	DC	DC	DC	EB	EB	EB	EB	EB	EE	
2,400 pF	242	F	F	G	J	K	M	BB	BB	BB	BB	BB	UD		CB	CB	CB	CB	CB	CB	UD	DC	DC	DC	DC	DC	EB	EB	EB	EB	EB	EC	
2,700 pF	272	F	F	G	J	K	M	BB	BB	BB	BB	BB	UD		CB	CB	CB	CB	CB	CB	UD	DC	DC	DC	DC	DC	EB	EB	EB	EB	EB	EC	
Cap	Cap Code	Voltage DC		10	16	25	50	100	200	10	16	25	50	100	200	10	16	25	50	100	200	10	16	25	50	100	200	10	16	25	50	100	200
		Voltage Code		8	4	3	5	2	1	8	4	3	5	1	2	8	4	3	5	1	2	8	4	3	5	1	2	8	4	3	5	1	2
		Series		C0402						C0603						C0805						C1206											

UD = Under Development

KEMET reserves the right to substitute product with an improved temperature characteristic, tighter capacitance tolerance and/or higher voltage capability within the same form factor (configuration and dimensions).

These products are protected under US Patents 7,172,985 & 7,670,981, other patents pending, and any foreign counterparts.

Table 1A – (0402 - 1206 Case Sizes) con't

Cap	Cap Code	Series	C0402						C0603						C0805						C1206					
		Voltage Code	8	4	3	5	1	2	8	4	3	5	1	2	8	4	3	5	1	2	8	4	3	5	1	2
		Voltage DC	10	16	25	50	100	200	10	16	25	50	100	200	10	16	25	50	100	200	10	16	25	50	100	200
		Cap Tolerance	Product Availability and Chip Thickness Codes - See Table 2 for Chip Thickness Dimensions																							
3,000 pF	302	F G J K M							CB	CB	CB	CB	CB		DD	DD	DD	DD	DC	UD	EC	EC	EC	EC	EC	UD
3,300 pF	332	F G J K M							CB	CB	CB	CB	CB		DD	DD	DD	DD	DC	UD	EC	EC	EC	EC	EE	UD
3,600 pF	362	F G J K M							CB	CB	CB	CB	CB		DD	DD	DD	DD	DC	UD	EC	EC	EC	EC	EE	UD
3,900 pF	392	F G J K M							CB	CB	CB	CB	CB		DE	DE	DE	DE	DC	UD	EC	EC	EC	EC	EF	UD
4,300 pF	432	F G J K M							CB	CB	CB	CB	CB		DE	DE	DE	DE	DC	UD	EC	EC	EC	EC	EC	UD
4,700 pF	472	F G J K M							CB	CB	CB	CB	CB		DE	DE	DE	DE	DC	UD	EC	EC	EC	EC	EC	UD
5,100 pF	512	F G J K M							CB	CB	CB	CB	CB		DE	DE	DE	DE	DC	UD	ED	ED	ED	ED	ED	UD
5,600 pF	562	F G J K M							CB	CB	CB	CB	CB		DC	DC	DC	DC	DC	UD	ED	ED	ED	ED	ED	UD
6,200 pF	622	F G J K M							CB	CB	CB	CB	CB		DC	DC	DC	DC	DC	UD	ED	EB	EB	EB	EB	UD
6,800 pF	682	F G J K M							CB	CB	CB	CB	CB		DC	DC	DC	DC	DC	UD	EB	EB	EB	EB	EB	UD
7,500 pF	752	F G J K M							CB	CB	CB	CB	CB		DC	DC	DC	DC	DC	UD	EB	EB	EB	EB	EB	UD
8,200 pF	822	F G J K M							CB	CB	CB	CB	CB		DC	DC	DC	DC	DC	UD	EC	EC	EC	EC	EB	UD
9,100 pF	912	F G J K M							CB	CB	CB	CB	CB		DC	DC	DC	DC	DC	UD	EC	EC	EC	EC	EB	UD
10,000 pF	103	F G J K M							CB	CB	CB	CB	CB		DC	DC	DC	DC	DD		ED	ED	ED	ED	EB	UD
12,000 pF	123	F G J K M							CB	CB	CB	CB	CB		DC	DC	DC	DC	DE		EB	EB	EB	EB	EB	UD
15,000 pF	153	F G J K M							CB	CB	CB	CB	CB		DC	DC	DC	DC	DG		EB	EB	EB	EB	EB	UD
18,000 pF	183	F G J K M							CB	CB	CB	CB	CB		DC	DC	DC	DD			EB	EB	EB	EB	EB	UD
22,000 pF	223	F G J K M													DD	DD	DD	DF			EB	EB	EB	EB	EC	UD
27,000 pF	273	F G J K M													DF	DF	DF				EB	EB	EB	EB	EE	
33,000 pF	333	F G J K M													DG	DG	DG				EB	EB	EB	EB	EE	
39,000 pF	393	F G J K M													DG	DG	DG				EC	EC	EC	EE	EH	
47,000 pF	473	F G J K M													DG	DG	DG				EC	EC	EC	EE	EH	
56,000 pF	563	F G J K M																			ED	ED	ED	EF		
68,000 pF	683	F G J K M																			EF	EF	EF	EH		
82,000 pF	823	F G J K M																			EH	EH	EH	EH		
0.10 µF	104	F G J K M																			EH	EH	EH			
Cap	Cap Code	Voltage DC	10	16	25	50	100	200	10	16	25	50	100	200	10	16	25	50	100	200	10	16	25	50	100	200
Cap	Cap Code	Voltage Code	8	4	3	5	2	1	8	4	3	5	1	2	8	4	3	5	1	2	8	4	3	5	1	2
Cap	Cap Code	Series	C0402						C0603						C0805						C1206					

Table 1B – (1210 - 2225 Case Sizes)

Cap	Cap Code	Series	C1210						C1808			C1812			C1825			C2220			C2225				
		Voltage Code	8	4	3	5	1	2	5	1	2	5	1	2	5	1	2	3	1	2	5	1	2		
		Voltage DC	10	16	25	50	100	200	50	100	200	50	100	200	50	100	200	50	100	200	50	100	200		
		Cap Tolerance	Product Availability and Chip Thickness Codes - See Table 2 for Chip Thickness Dimensions																						
0.5-0.75 pF	508-758	D																							
1.0-2.4 pF	109-249	D																							
2.7-9.1 pF	279-919	D																							
10-13 pF	100-130	D																							
15-24 pF	150-240	D																							
27-51 pF	270-510	D	F	G	J	K	M	FB	FB	FB	FB	FB	FB												
56-82 pF	560-820	D	F	G	J	K	M	FB	FB	FB	FB	FB	FB												
91-200 pF	910-201	D	F	G	J	K	M	FB	FB	FB	FB	FB	FB												
220-300 pF	221-301	D	F	G	J	K	M	FB	FB	FB	FB	FB	FB												
330-430 pF	331-431	D	F	G	J	K	M	FB	FB	FB	FB	FB	FB	LE	LE	LE									
470-910 pF	471-911	D	F	G	J	K	M	FB	FB	FB	FB	FB	FB	LE	LE	LE	GB	GB	GB						
1,000 pF	102	D	F	G	J	K	M	FB	FB	FB	FB	FB	FB	LE	LE	LE	GB	GB	GB						
Cap	Cap Code	Voltage DC	10	16	25	50	100	200	50	100	200	50	100	200	50	100	200	50	100	200	50	100	200		
Cap	Cap Code	Voltage Code	8	4	3	5	1	2	5	1	2	5	1	2	5	1	2	3	1	2	5	1	2		
Cap	Cap Code	Series	C1210						C1808			C1812			C1825			C2220			C2225				

UD = Under Development

KEMET reserves the right to substitute product with an improved temperature characteristic, tighter capacitance tolerance and/or higher voltage capability within the same form factor (configuration and dimensions).

These products are protected under US Patents 7,172,985 & 7,670,981, other patents pending, and any foreign counterparts.

Table 2 – Chip Thickness/Packaging Quantities

Thickness Code	Chip Size	Thickness ± Range (mm)	QTY per Reel 7" Plastic	QTY per Reel 13" Plastic	QTY per Reel 7" Paper	QTY per Reel 13" Paper	QTY per Bulk Cassette
AA	1005	0.20 ± 0.02			15000		
AB	0201	0.30 ± 0.03			15000		
BB	0402	0.50 ± 0.05			10000	50000	50000
BC	0402	0.50 ± 0.10			10000	50000	50000
PA	0508	0.80 ± 0.10	4000	10000			
CB	0603	0.80 ± 0.07			4000	10000	15000
CC	0603	0.80 ± 0.10			4000	10000	15000
CD	0603	0.80 ± 0.15			4000	10000	15000
MA	0612	0.80 ± 0.10	4000	10000			
DB	0805	0.60 ± 0.10			4000	10000	15000
DC	0805	0.78 ± 0.10			4000	10000	15000
DD	0805	0.90 ± 0.10			4000	10000	15000
DL	0805	0.95 ± 0.10	4000	10000			
DE	0805	1.00 ± 0.10	2500	10000			
DF	0805	1.10 ± 0.10	2500	10000			
DG	0805	1.25 ± 0.15	2500	10000			
DH	0805	1.25 ± 0.20	2500	10000			
EB	1206	0.78 ± 0.10	4000	10000	4000	10000	
EK	1206	0.80 ± 0.10	2000	8000			
EC	1206	0.90 ± 0.10	4000	10000			
EN	1206	0.95 ± 0.10	4000	10000			
ED	1206	1.00 ± 0.10	2500	10000			
EE	1206	1.10 ± 0.10	2500	10000			
EF	1206	1.20 ± 0.15	2500	10000			
EM	1206	1.25 ± 0.15	2500	10000			
EG	1206	1.60 ± 0.15	2000	8000			
EH	1206	1.60 ± 0.20	2000	8000			
EJ	1206	1.70 ± 0.20	2000	8000			
FB	1210	0.78 ± 0.10	4000	10000			
FC	1210	0.90 ± 0.10	4000	10000			
FD	1210	0.95 ± 0.10	4000	10000			
FE	1210	1.00 ± 0.10	2500	10000			
FF	1210	1.10 ± 0.10	2500	10000			
FG	1210	1.25 ± 0.15	2500	10000			
FL	1210	1.40 ± 0.15	2000	8000			
FO	1210	1.50 ± 0.20	2000	8000			
FH	1210	1.55 ± 0.15	2000	8000			
FP	1210	1.60 ± 0.20	2000	8000			
FM	1210	1.70 ± 0.20	2000	8000			
FJ	1210	1.85 ± 0.20	2000	8000			
FN	1210	1.85 ± 0.20	2000	8000			
FT	1210	1.90 ± 0.20	1500	4000			
FK	1210	2.10 ± 0.20	2000	8000			
FR	1210	2.25 ± 0.20	2000	8000			
FS	1210	2.50 ± 0.20	1000	4000			
FV	1210	3.35 ± 0.10	500	1800			
FW	1210	6.15 ± 0.15	200	1000			
PA	1220	0.80 ± 0.10	4000	10000			
MA	1632	0.80 ± 0.10	4000	10000			
NA	1706	0.90 ± 0.10	4000	10000			
NB	1706	1.00 ± 0.10	4000	10000			
NC	1706	1.00 ± 0.15	4000	10000			
LD	1808	0.90 ± 0.10	2500	10000			
LE	1808	1.00 ± 0.10	2500	10000			
LF	1808	1.00 ± 0.15	2500	10000			
LA	1808	1.40 ± 0.15	1000	4000			
LB	1808	1.60 ± 0.15	1000	4000			
LC	1808	2.00 ± 0.15	1000	4000			
GB	1812	1.00 ± 0.10	1000	4000			
GC	1812	1.10 ± 0.10	1000	4000			
GD	1812	1.25 ± 0.15	1000	4000			
GE	1812	1.30 ± 0.10	1000	4000			
GH	1812	1.40 ± 0.15	1000	4000			
GF	1812	1.50 ± 0.10	1000	4000			
GG	1812	1.55 ± 0.10	1000	4000			
GK	1812	1.60 ± 0.20	1000	4000			
GJ	1812	1.70 ± 0.15	1000	4000			
GN	1812	1.70 ± 0.20	1000	4000			
GL	1812	1.90 ± 0.20	1000	4000			
GM	1812	2.00 ± 0.20	1000	4000			
GO	1812	2.50 ± 0.20	500	2000			
GP	1812	2.65 ± 0.35	500	1400			
GR	1812	5.00 ± 0.50	350	1000			
HB	1825	1.10 ± 0.15	1000	4000			
HC	1825	1.15 ± 0.15	1000	4000			
HD	1825	1.30 ± 0.15	1000	4000			
HE	1825	1.40 ± 0.15	1000	4000			
HF	1825	1.50 ± 0.15	1000	4000			
Thickness Code	Chip Size	Thickness ± Range (mm)	QTY per Reel 7" Plastic	QTY per Reel 13" Plastic	QTY per Reel 7" Paper	QTY per Reel 13" Paper	QTY per Bulk Cassette

Package Quantity
 Based on Finished Chip
 Thickness Specifications

Table 2 – Chip Thickness/Packaging Quantities con’t

Thickness Code	Chip Size	Thickness ± Range (mm)	QTY per Reel 7" Plastic	QTY per Reel 13" Plastic	QTY per Reel 7" Paper	QTY per Reel 13" Paper	QTY per Bulk Cassette
HG	1825	1.60 ± 0.20	1000	4000			
JB	2220	1.00 ± 0.15	1000	4000			
JC	2220	1.10 ± 0.15	1000	4000			
JD	2220	1.30 ± 0.15	1000	4000			
JE	2220	1.40 ± 0.15	1000	4000			
JF	2220	1.50 ± 0.15	1000	4000			
JP	2220	1.60 ± 0.20	1000	4000			
JG	2220	1.70 ± 0.15	1000	4000			
JH	2220	1.80 ± 0.15	1000	4000			
JO	2220	2.40 ± 0.15	500	2000			
JP	2220	3.50 ± 0.30	250	850			
JR	2220	5.00 ± 0.50	150	600			
KB	2225	1.00 ± 0.15	1000	4000			
KC	2225	1.10 ± 0.15	1000	4000			
KD	2225	1.30 ± 0.15	1000	4000			
KE	2225	1.40 ± 0.15	1000	4000			
KF	2225	1.60 ± 0.20	1000	4000			
Thickness Code	Chip Size	Thickness ± Range (mm)	QTY per Reel 7" Plastic	QTY per Reel 13" Plastic	QTY per Reel 7" Paper	QTY per Reel 13" Paper	QTY per Bulk Cassette

Table 3 – Chip Capacitor Land Pattern Design Recommendations per IPC-7351

EIA Size Code	Metric Size Code	Density Level A: Maximum (Most) Land Protrusion (mm)					Density Level B: Median (Nominal) Land Protrusion (mm)					Density Level C: Minimum (Least) Land Protrusion (mm)				
		C	Y	X	V1	V2	C	Y	X	V1	V2	C	Y	X	V1	V2
01005	0402	0.33	0.46	0.43	1.60	0.90	0.28	0.36	0.33	1.30	0.70	0.23	0.26	0.23	1.00	0.50
0201	0603	0.38	0.56	0.52	1.80	1.00	0.33	0.46	0.42	1.50	0.80	0.28	0.36	0.32	1.20	0.60
0402	1005	0.50	0.72	0.72	2.20	1.20	0.45	0.62	0.62	1.90	1.00	0.40	0.52	0.52	1.60	0.80
0603	1608	0.90	1.15	1.10	4.00	2.10	0.80	0.95	1.00	3.10	1.50	0.60	0.75	0.90	2.40	1.20
0805	2012	1.00	1.35	1.55	4.40	2.60	0.90	1.15	1.45	3.50	2.00	0.75	0.95	1.35	2.80	1.70
1206	3216	1.60	1.35	1.90	5.60	2.90	1.50	1.15	1.80	4.70	2.30	1.40	0.95	1.70	4.00	2.00
1210	3225	1.60	1.35	2.80	5.65	3.80	1.50	1.15	2.70	4.70	3.20	1.40	0.95	2.60	4.00	2.90
1808	4520	2.30	1.75	2.30	7.40	3.30	2.20	1.55	2.20	6.50	2.70	2.10	1.35	2.10	5.80	2.40
1812	4532	2.15	1.60	3.60	6.90	4.60	2.05	1.40	3.50	6.00	4.00	1.95	1.20	3.40	5.30	3.70
1825	4564	2.15	1.60	6.90	6.90	7.90	2.05	1.40	6.80	6.00	7.30	1.95	1.20	6.70	5.30	7.00
2220	5650	2.75	1.70	5.50	8.20	6.50	2.65	1.50	5.40	7.30	5.90	2.55	1.30	5.30	6.60	5.60
2225	5664	2.70	1.70	6.90	8.10	7.90	2.60	1.50	6.80	7.20	7.30	2.50	1.30	6.70	6.50	7.00

Density Level A: For low-density Product applications. Recommended for wave solder applications and provides a wider process window for reflow solder processes. KEMET only recommends wave soldering of EIA 0603, 0805 and 1206 case sizes.

Density Level B: For products with a moderate level of component density. Provides a robust solder attachment condition for reflow solder processes.

Density Level C: For high component density product applications. Before adapting the minimum land pattern variations the user should perform qualification testing based on the conditions outlined in IPC standard 7351 (IPC-7351).

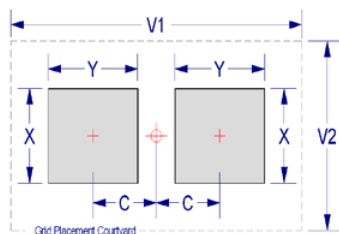

Soldering Process

Recommended Soldering Technique:

- Solder wave or solder reflow for EIA case sizes 0603, 0805 and 1206
- All other EIA case sizes are limited to solder reflow only

Recommended Soldering Profile:

- KEMET recommends following the guidelines outlined in IPC/JEDEC J-STD-020

Table 4 – Performance & Reliability: Test Methods and Conditions

Stress	Reference	Test or Inspection Method
Terminal Strength	JIS-C-6429	Appendix 1, Note: Force of 1.8kg for 60 seconds.
Board Flex	JIS-C-6429	Appendix 2, Note: 2mm (min) for all except 3mm for C0G.
Solderability	J-STD-002	Magnification 50 X. Conditions:
		a) Method B, 4 hours @ 155°C, dry heat @ 235°C
		b) Method B @ 215°C category 3
		c) Method D, category 3 @ 260°C
Temperature Cycling	JESD22 Method JA-104	1000 cycles (-55°C to +125°C), Measurement at 24 hours. +/- 2 hours after test conclusion.
Biased Humidity	MIL-STD-202 Method 103	Load Humidity: 1000 hours 85°C/85%RH and Rated Voltage. Add 100K ohm resistor. Measurement at 24 hours. +/- 2 hours after test conclusion.
		Low Volt Humidity: 1000 hours 85°C/85%RH and 1.5V. Add 100K ohm resistor. Measurement at 24 hours. +/- 2 hours after test conclusion.
Moisture Resistance	MIL-STD-202 Method 106	t = 24 hours/cycle. Steps 7a & 7b not required. Unpowered. Measurement at 24 hours. +/- 2 hours after test conclusion.
Thermal Shock	MIL-STD-202 Method 107	-55°C/+125°C. Note: Number of cycles required-300, maximum transfer time-20 seconds, dwell time-15 minutes. Air-Air.
High Temperature Life	MIL-STD-202 Method 108 / EIA -198	1000 hours at 125°C (85°C for X5R, Z5U and Y5V) with 2 X rated voltage applied.
Storage Life	MIL-STD-202 Method 108	150°C, 0VDC, for 1000 hours.
Mechanical Shock	MIL-STD-202 Method 213	Figure 1 of Method 213, Condition F.
Resistance to Solvents	MIL-STD-202 Method 215	Add aqueous wash chemical - OKEM Clean or equivalent.

Storage and Handling

Ceramic chip capacitors should be stored in normal working environments. While the chips themselves are quite robust in other environments, solderability will be degraded by exposure to high temperatures, high humidity, corrosive atmospheres, and long term storage. In addition, packaging materials will be degraded by high temperature – reels may soften or warp, and tape peel force may increase. KEMET recommends that maximum storage temperature not exceed 40°C, and maximum storage humidity not exceed 70% relative humidity. In addition, temperature fluctuations should be minimized to avoid condensation on the parts, and atmospheres should be free of chlorine and sulfur bearing compounds. For optimized solderability, chip stock should be used promptly, preferably within 1.5 years of receipt.

Tape & Reel Packaging Information

KEMET offers Multilayer Ceramic Chip Capacitors packaged in 8mm, 12mm and 16mm tape on 7" and 13" reels in accordance with EIA standard 481. This packaging system is compatible with all tape fed automatic pick and place systems. See Table 2 for details on reeling quantities for commercial chips.

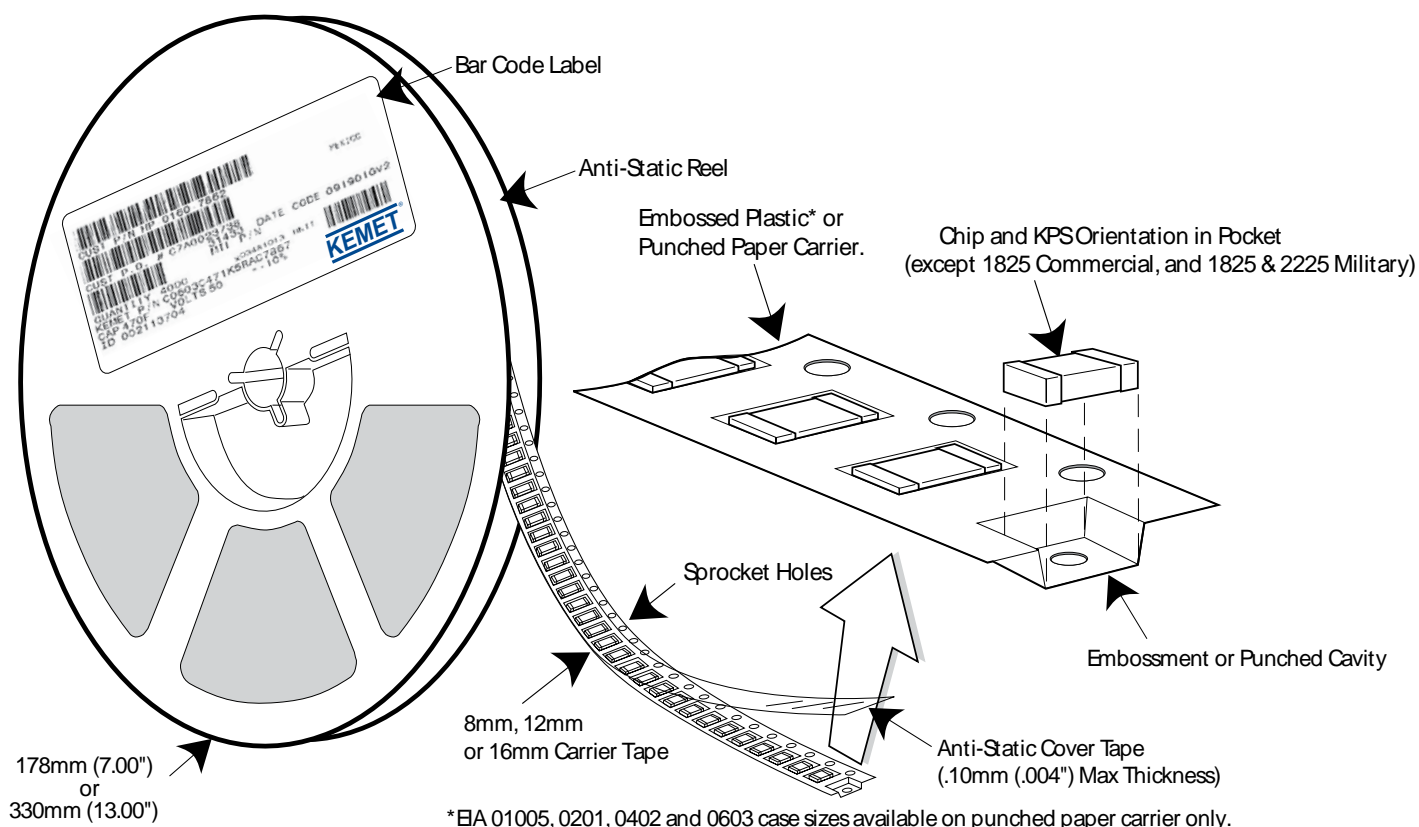

Table 5 – Carrier Tape Configuration (mm)

EIA Case Size	Tape size (W)*	Pitch (P ₁)*
01005 - 0402	8	2
0603 - 1210	8	4
1805 - 1808	12	4
≥ 1812	12	8
KPS 1210	12	8
KPS 1812 & 2220	16	12
Array 0508 & 0612	8	4

*Refer to Figure 1 for W and P₁ carrier tape reference locations.

*Refer to Table 6 for tolerance specifications.

Figure 1 – Embossed (Plastic) Carrier Tape Dimensions

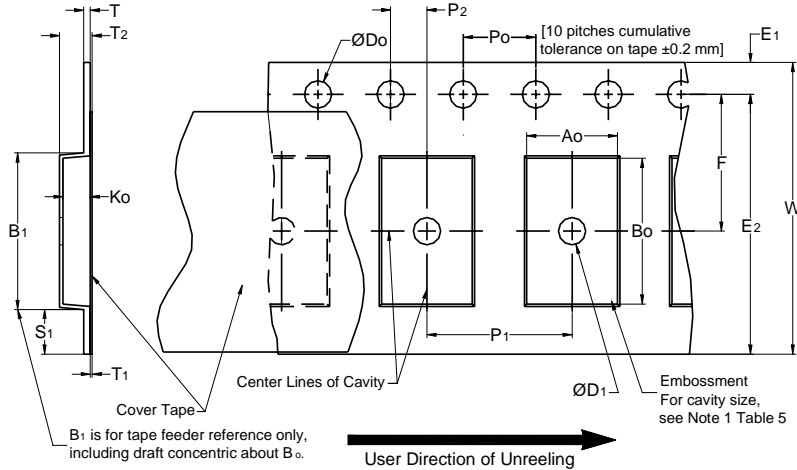

Table 6 – Embossed (Plastic) Carrier Tape Dimensions

Metric will govern

Constant Dimensions — Millimeters (Inches)									
Tape Size	D_0	D_1 Min. Note 1	E_1	P_0	P_2	R Ref. Note 2	S_1 Min. Note 3	T Max.	T_1 Max.
8mm	$1.5 +0.10/-0.0$ ($0.059 +0.004/-0.0$)	1.0 (0.039)	1.75 ± 0.10 (0.069 ± 0.004)	4.0 ± 0.10 (0.157 ± 0.004)	2.0 ± 0.05 (0.079 ± 0.002)	25.0 (0.984)	0.600 (0.024)	0.600 (0.024)	0.100 (0.004)
12mm		1.5 (0.059)				30 (1.181)			
16mm									
Variable Dimensions — Millimeters (Inches)									
Tape Size	Pitch	B_1 Max. Note 4	E_2 Min.	F	P_1	T_2 Max	W Max	A_0, B_0 & K_0	
8mm	Single (4mm)	4.35 (0.171)	6.25 (0.246)	3.5 ± 0.05 (0.138 ± 0.002)	4.0 ± 0.10 (0.157 ± 0.004)	2.5 (0.098)	8.3 (0.327)	Note 5	
12mm	Single (4mm) & Double (8mm)	8.2 (0.323)	10.25 (0.404)	5.5 ± 0.05 (0.217 ± 0.002)	8.0 ± 0.10 (0.315 ± 0.004)	4.6 (0.181)	12.3 (0.484)		
16mm	Triple (12mm)	12.1 (0.476)	14.25 (0.561)	5.5 ± 0.05 (0.217 ± 0.002)	8.0 ± 0.10 (0.315 ± 0.004)	4.6 (0.181)	16.3 (0.642)		

1. The embossment hole location shall be measured from the sprocket hole controlling the location of the embossment. Dimensions of embossment location and hole location shall be applied independent of each other.
2. The tape with or without components shall pass around R without damage (see Figure 5).
3. If $S_1 < 1.0$ mm, there may not be enough area for cover tape to be properly applied (see EIA Document 481 paragraph 4.3 (b)).
4. B_1 dimension is a reference dimension for tape feeder clearance only.
5. The cavity defined by A_0 , B_0 and K_0 shall surround the component with sufficient clearance that:
 - (a) the component does not protrude above the top surface of the carrier tape.
 - (b) the component can be removed from the cavity in a vertical direction without mechanical restriction, after the top cover tape has been removed.
 - (c) rotation of the component is limited to 20° maximum for 8 and 12mm tapes and 10° maximum for 16mm tapes (see Figure 3).
 - (d) lateral movement of the component is restricted to 0.5 mm maximum for 8mm and 12mm wide tape and to 1.0mm maximum for 16mm tape (see Figure 4).
 - (e) for KPS Series product A_0 and B_0 are measured on a plane 0.3mm above the bottom of the pocket.
 - (f) see Addendum in EIA Document 481 for standards relating to more precise taping requirements.

Figure 2 – Punched (Paper) Carrier Tape Dimensions

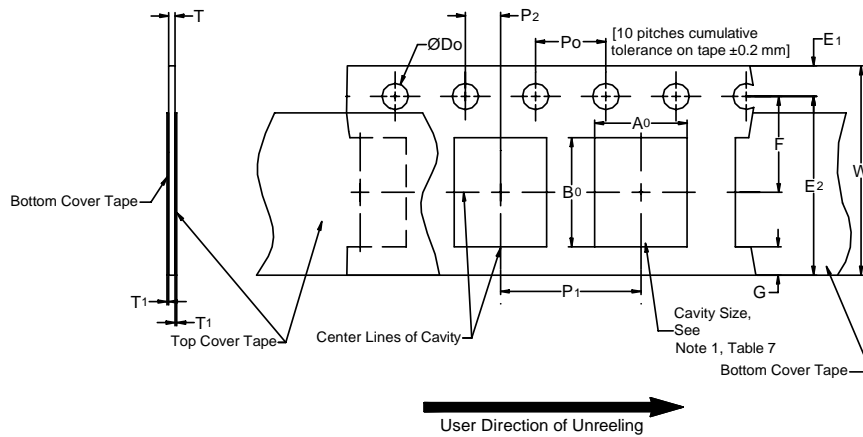

Table 7 – Punched (Paper) Carrier Tape Dimensions

Metric will govern

Constant Dimensions — Millimeters (Inches)							
Tape Size	D ₀	E ₁	P ₀	P ₂	T ₁ Max	G Min	R Ref. Note 2
8mm	1.5 +0.10-0.0 (0.059 +0.004, -0.0)	1.75 ±0.10 (0.069 ±0.004)	4.0 ±0.10 (0.157 ±0.004)	2.0 ±0.05 (0.079 ±0.002)	0.10 (.004) Max.	0.75 (.030)	25 (.984)
Variable Dimensions — Millimeters (Inches)							
Tape Size	Pitch	E2 Min	F	P ₁	T Max	W Max	A ₀ B ₀
8mm	Half (2mm)	6.25 (0.246)	3.5 ± 0.05 (0.138 ± 0.002)	2.0 ± 0.05 (0.079 ± 0.002)	1.1 (0.098)	8.3 (0.327)	Note 5
8mm	Single (4mm)			4.0 ± 0.10 (0.157 ± 0.004)		8.3 (0.327)	

- The cavity defined by A₀, B₀ and T shall surround the component with sufficient clearance that:
 - the component does not protrude beyond either surface of the carrier tape.
 - the component can be removed from the cavity in a vertical direction without mechanical restriction, after the top cover tape has been removed.
 - lateral movement of the component is restricted to 0.5 mm maximum (see Figure 4).
 - see Addendum in EIA Document 481 for standards relating to more precise taping requirements.
- The tape with or without components shall pass around R without damage (see Figure 5).

Packaging Information Performance Notes

1. **Cover Tape Break Force:** 1.0 Kg Minimum.
2. **Cover Tape Peel Strength:** The total peel strength of the cover tape from the carrier tape shall be:

Tape Width	Peel Strength
8mm	0.1 Newton to 1.0 Newton (10gf to 100gf)
12mm & 16mm	0.1 Newton to 1.3 Newton (10gf to 130gf)

The direction of the pull shall be opposite the direction of the carrier tape travel. The pull angle of the carrier tape shall be 165° to 180° from the plane of the carrier tape. During peeling, the carrier and/or cover tape shall be pulled at a velocity of 300±10 mm/minute.

3. **Labeling:** Bar code labeling (standard or custom) shall be on the side of the reel opposite the sprocket holes. Refer to EIA-556 and EIA-624.

Figure 3 – Maximum Component Rotation

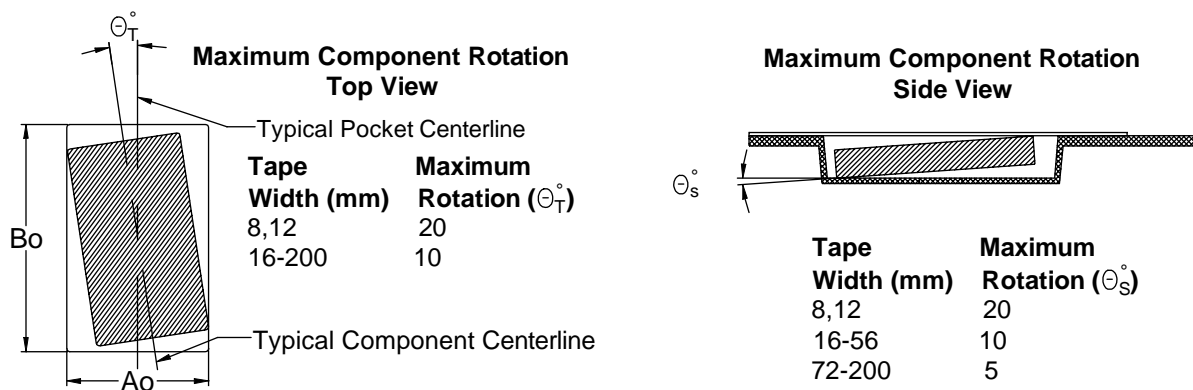

Figure 4 – Maximum Lateral Movement

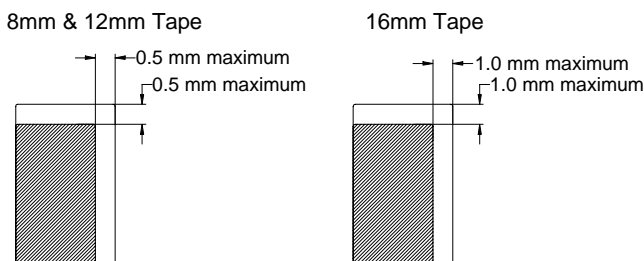

Figure 5 – Bending Radius

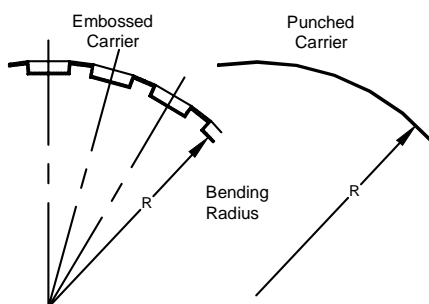
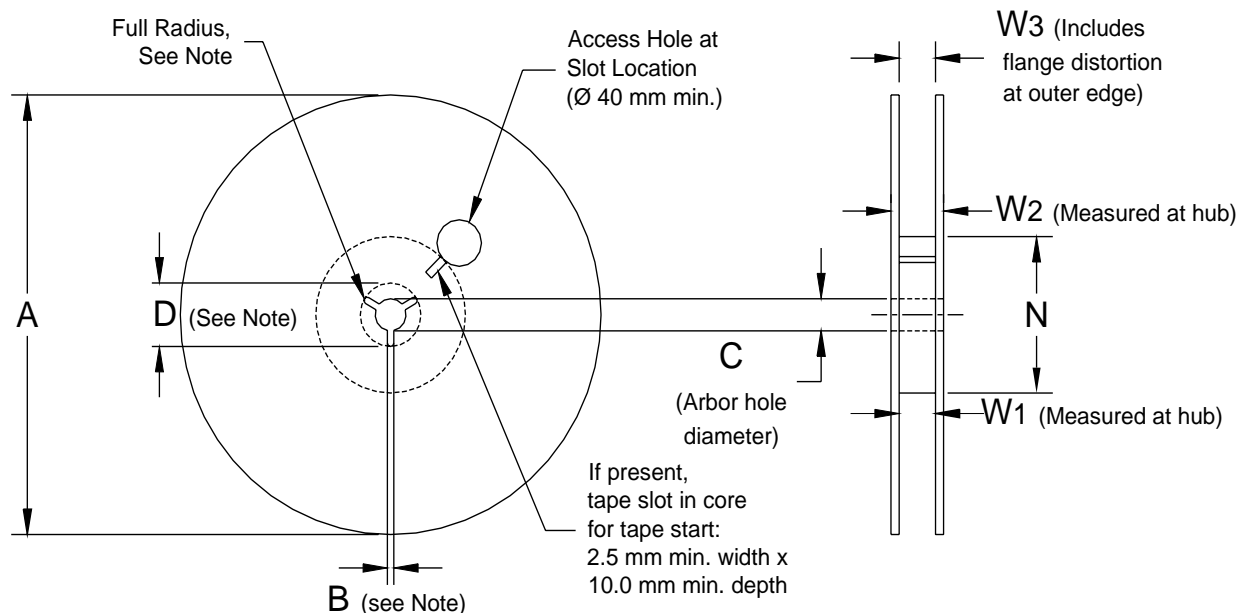

Figure 6 – Reel Dimensions



Note: Drive spokes optional; if used, dimensions B and D shall apply.

Table 8 – Reel Dimensions

Metric will govern

Constant Dimensions — Millimeters (Inches)				
Tape Size	A	B Min	C	D Min
8mm	178 ± 0.20 (7.008 ± 0.008) or 330 ± 0.20 (13.000 ± 0.008)	1.5 (0.059)	$13.0 +0.5/-0.2$ (0.521 +0.02/-0.008)	20.2 (0.795)
12mm				
16mm				
Variable Dimensions — Millimeters (Inches)				
Tape Size	N Min	W ₁	W ₂ Max	W ₃
8mm	50 (1.969)	$8.4 +1.5/-0.0$ (0.331 +0.059/-0.0)	14.4 (0.567)	Shall accommodate tape width without interference
12mm		$12.4 +2.0/-0.0$ (0.488 +0.078/-0.0)	18.4 (0.724)	
16mm		$16.4 +2.0/-0.0$ (0.646 +0.078/-0.0)	22.4 (0.882)	

Figure 7 – Tape Leader & Trailer Dimensions

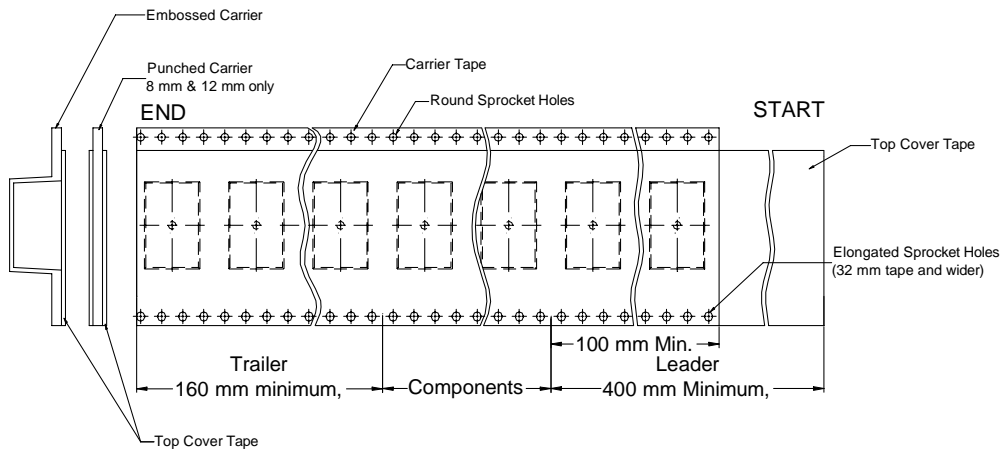

Figure 8 – Maximum Camber

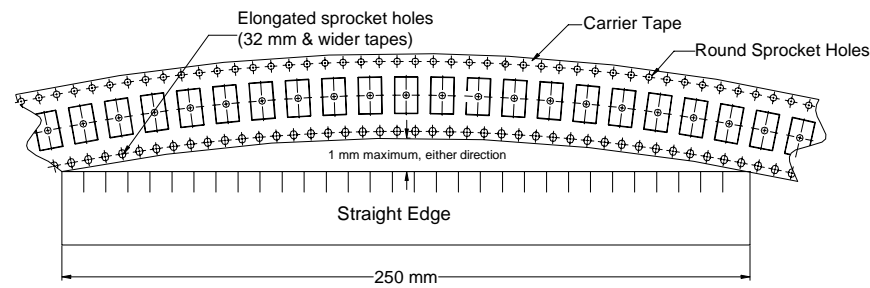

Figure 9 – Bulk Cassette Packaging (Ceramic Chips Only)

Meets Dimensional Requirements IEC-286 and EIAJ 7201

Unit mm *Reference

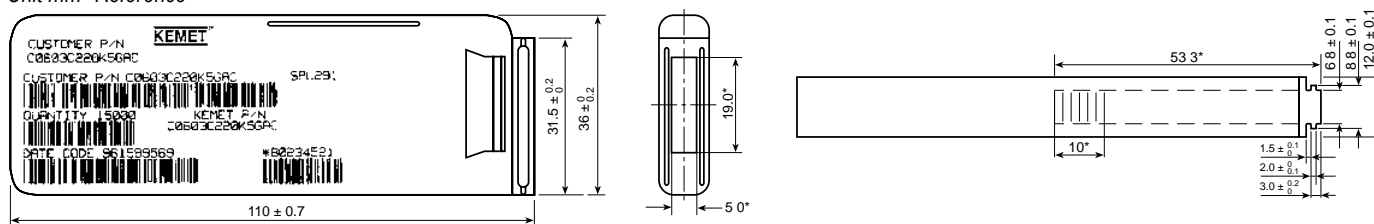

Table 9 – Capacitor Dimensions for Bulk Cassette

Cassette Packaging – Millimeters

EIA Size Code	Metric Size Code	L Length	W Width	B Bandwidth	S Separation minimum	T Thickness	Number of Pcs/Cassette
0402	1005	1.0 ± 0.05	0.5 ± 0.05	0.2 to 0.4	0.3	0.5 ± .05	50,000
0603	1608	1.6 ± 0.07	0.8 ± 0.07	0.2 to 0.5	0.7	0.8 ± .07	15,000

Table 10 – Capacitor Marking

Laser marking is available as an extra-cost option for most KEMET ceramic chips. Such marking is two sided, and includes a K to identify KEMET, followed by two characters (per EIA-198) to identify the capacitance value. Note that marking is not available for any Y5V chip. In addition, the 0603 marking option is limited to the K only. (Marking Optional – Not Available for 0402 Size)

Numeral Alpha Character	Capacitance (pF) For Various Numeral Identifiers									
	9	0	1	2	3	4	5	6	7	
A	0.1	1	10	100	1000	10000	100000	1000000	10000000	
B	0.11	1.1	11	110	1100	11000	110000	1100000	11000000	
C	0.12	1.2	12	120	1200	12000	120000	1200000	12000000	
D	0.13	1.3	13	130	1300	13000	130000	1300000	13000000	
E	0.15	1.5	15	150	1500	15000	150000	1500000	15000000	
F	0.16	1.6	16	160	1600	16000	160000	1600000	16000000	
G	0.18	1.8	18	180	1800	18000	180000	1800000	18000000	
H	0.2	2	20	200	2000	20000	200000	2000000	20000000	
J	0.22	2.2	22	220	2200	22000	220000	2200000	22000000	
K	0.24	2.4	24	240	2400	24000	240000	2400000	24000000	
L	0.27	2.7	27	270	2700	27000	270000	2700000	27000000	
M	0.3	3	30	300	3000	30000	300000	3000000	30000000	
N	0.33	3.3	33	330	3300	33000	330000	3300000	33000000	
P	0.36	3.6	36	360	3600	36000	360000	3600000	36000000	
Q	0.39	3.9	39	390	3900	39000	390000	3900000	39000000	
R	0.43	4.3	43	430	4300	43000	430000	4300000	43000000	
S	0.47	4.7	47	470	4700	47000	470000	4700000	47000000	
T	0.51	5.1	51	510	5100	51000	510000	5100000	51000000	
U	0.56	5.6	56	560	5600	56000	560000	5600000	56000000	
V	0.62	6.2	62	620	6200	62000	620000	6200000	62000000	
W	0.68	6.8	68	680	6800	68000	680000	6800000	68000000	
X	0.75	7.5	75	750	7500	75000	750000	7500000	75000000	
Y	0.82	8.2	82	820	8200	82000	820000	8200000	82000000	
Z	0.91	9.1	91	910	9100	91000	910000	9100000	91000000	
a	0.25	2.5	25	250	2500	25000	250000	2500000	25000000	
b	0.35	3.5	35	350	3500	35000	350000	3500000	35000000	
d	0.4	4	40	400	4000	40000	400000	4000000	40000000	
e	0.45	4.5	45	450	4500	45000	450000	4500000	45000000	
f	0.5	5	50	500	5000	50000	500000	5000000	50000000	
m	0.6	6	60	600	6000	60000	600000	6000000	60000000	
n	0.7	7	70	700	7000	70000	700000	7000000	70000000	
t	0.8	8	80	800	8000	80000	800000	8000000	80000000	
y	0.9	9	90	900	9000	90000	900000	9000000	90000000	

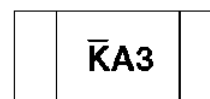

Example shown is 1,000 pF capacitor

KEMET Corporation World Headquarters

2835 KEMET Way
Simpsonville, SC 29681

Mailing Address:
P.O. Box 5928
Greenville, SC 29606

www.kemet.com
Tel: 864-963-6300
Fax: 864-963-6521

Corporate Offices

Fort Lauderdale, FL
Tel: 954-766-2800

North America

Southeast

Lake Mary, FL
Tel: 407-855-8886

Northeast

Wilmington, MA
Tel: 978-658-1663

West Chester, PA
Tel: 610-692-4642

Central

Schaumburg, IL
Tel: 847-882-3590

Carmel, IN
Tel: 317-706-6742

West

Milpitas, CA
Tel: 408-433-9950

Mexico

Zapopan, Jalisco
Tel: 52-33-3123-2141

Europe

Southern Europe

Geneva, Switzerland
Tel: 41-22-715-0100

Paris, France
Tel: 33-1-4646-1009

Sasso Marconi, Italy
Tel: 39-051-939111

Milan, Italy
Tel: 39-02-57518176

Rome, Italy
Tel: 39-06-23231718

Madrid, Spain
Tel: 34-91-804-4303

Central Europe

Landsberg, Germany
Tel: 49-8191-3350800

Dortmund, Germany
Tel: 49-2307-3619672

Kwidzyn, Poland
Tel: 48-55-279-7025

Northern Europe

Bishop's Stortford, United Kingdom
Tel: 44-1279-757201

Weymouth, United Kingdom
Tel: 44-1305-830747

Coatbridge, Scotland
Tel: 44-1236-434455

Färjestaden, Sweden
Tel: 46-485-563934

Espoo, Finland
Tel: 358-9-5406-5000

Asia

Northeast Asia

Hong Kong
Tel: 852-2305-1168

Shenzhen, China
Tel: 86-755-2518-1306

Beijing, China
Tel: 86-10-5829-1711

Shanghai, China
Tel: 86-21-6447-0707

Taipei, Taiwan
Tel: 886-2-27528585

Southeast Asia

Singapore
Tel: 65-6586-1900

Penang, Malaysia
Tel: 60-4-6430200

Bangalore, India
Tel: 91-806-53-76817

Note: KEMET reserves the right to modify minor details of internal and external construction at any time in the interest of product improvement. KEMET does not assume any responsibility for infringement that might result from the use of KEMET Capacitors in potential circuit designs. KEMET is a registered trademark of KEMET Electronics Corporation.

Other KEMET Resources

Tools	
Resource	Location
Configure A Part: CapEdge	http://capacitoredge.kemet.com
SPICE & FIT Software	http://www.kemet.com/spice
Search Our FAQs: KnowledgeEdge	http://www.kemet.com/keask

Product Information	
Resource	Location
Products	http://www.kemet.com/products
Technical Resources (Including Soldering Techniques)	http://www.kemet.com/technicalpapers
RoHS Statement	http://www.kemet.com/rohs
Quality Documents	http://www.kemet.com/qualitydocuments

Product Request	
Resource	Location
Sample Request	http://www.kemet.com/sample
Engineering Kit Request	http://www.kemet.com/kits

Contact	
Resource	Location
Website	www.kemet.com
Contact Us	http://www.kemet.com/contact
Investor Relations	http://www.kemet.com/ir
Call Us	1-877-MyKEMET
Twitter	http://twitter.com/kemetcapacitors

Disclaimer

All product specifications, statements, information and data (collectively, the “Information”) are subject to change without notice.

All Information given herein is believed to be accurate and reliable, but is presented without guarantee, warranty, or responsibility of any kind, expressed or implied.

Statements of suitability for certain applications are based on our knowledge of typical operating conditions for such applications, but are not intended to constitute – and we specifically disclaim – any warranty concerning suitability for a specific customer application or use. This Information is intended for use only by customers who have the requisite experience and capability to determine the correct products for their application. Any technical advice inferred from this Information or otherwise provided by us with reference to the use of our products is given gratis, and we assume no obligation or liability for the advice given or results obtained.

Although we design and manufacture our products to the most stringent quality and safety standards, given the current state of the art, isolated component failures may still occur. Accordingly, customer applications which require a high degree of reliability or safety should employ suitable designs or other safeguards (such as installation of protective circuitry or redundancies) in order to ensure that the failure of an electrical component does not result in a risk of personal injury or property damage.

Although all product-related warnings, cautions and notes must be observed, the customer should not assume that all safety measures are indicated or that other measures may not be required.

